

PARTS GUIDE

BLOWER MOTORS / WHEELS

FITTINGS

BOWDEN CABLES

**HEATER CONTROL
VALVES**

CLASS A DUCTS / VENTS

HEATER CORES

COMPRESSOR GUIDE

HOSE

CONDENSER CHART

HOSE SPLICERS

CONDENSERS - RV

PRESSURE SWITCH

CONDENSERS - MISC

**RECEIVER DRIERS
& ACCESSORIES**

**CONDENSER FANS
& ACCESSORIES**

RESISTOR

CONTROL HEADS

SOLENOIDS

EVAPORATOR COILS

SWITCHES

EXPANSION VALVES

THERMOSTAT

FAN RELAY

TRINARY SWITCH

FITTING ID CHART

VACUUM PUMP

BLOWER MOTORS / WHEELS & ASSEMBLIES

**4100010 BLOWER MOTOR
4100000 BLOWER WHEEL**

12 Volt, double shaft electric motor. Three speed reversible, vented. 5/16" shaft. Shafts are 3" long. Blower wheel includes clip.

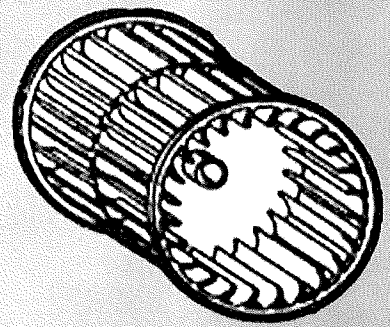
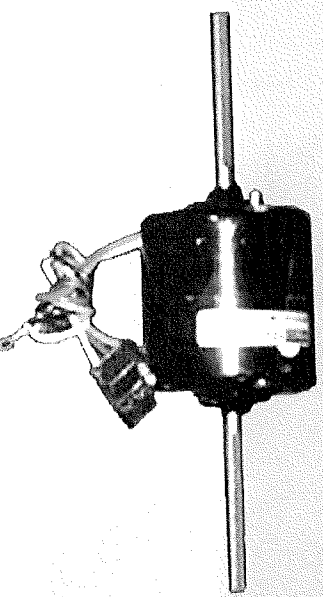

4100976 BLOWER MOTOR ASSEMBLY

Consists of the above motor, two of the above blower wheels, and assembly. Fits our 4212001 / 4212002 systems.

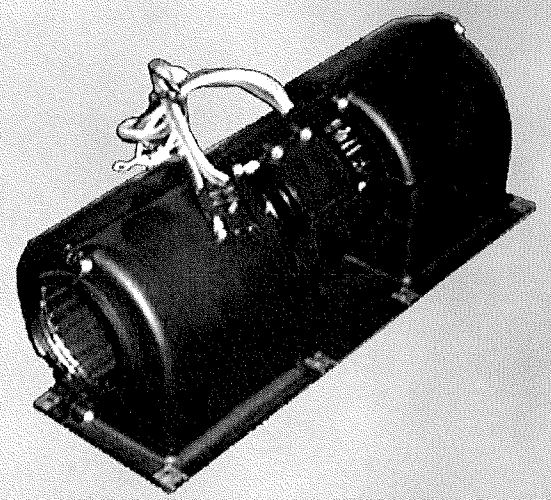

**4100336 BLOWER MOTOR
4102650 BLOWER WHEEL**

GM / Class A / Astro blower motor. Shaft is 1 3/16" long. Blower wheel includes clip.

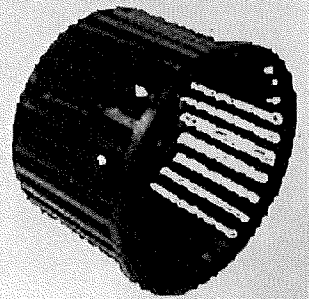

MISC. SMALL PARTS

RECEIVER DRIERS

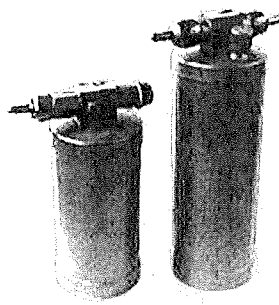

- 4103052 - 3/8" Inlet & outlet, w/switch port
- 4103050 - 3/8" Inlet & outlet, no switch port
- 4103054 - Standard GM 134a, no switch port
- 4103059 - GM 18mm x 12mm, metric switch port
- 4103061 - GM 18mm x 18mm, metric switch port
- 4103062 - GM 18mm x 18mm, metric switch port, welded mounting brkt.
- 4103063 - GM 18mm x 12mm, metric switch port, welded mounting brkt.



4103426
Quick connect drier fitting
male metric

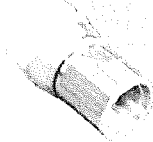

4103425
Quick connect drier fitting
female metric

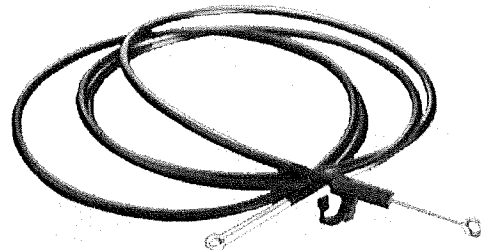

BOWDEN CABLES
4100589 - 106"
4103877 - 64"

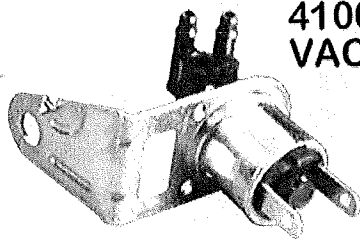

4100168
VACUUM SOLENOID

4100162
SOLENOID VALVE

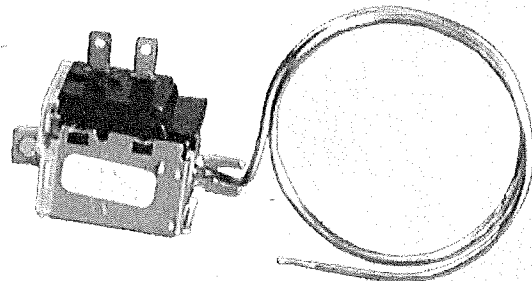
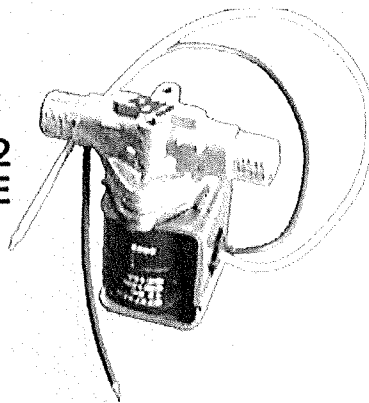

4100267
PRESET THERMOSTAT

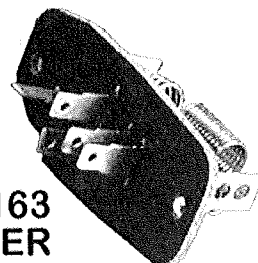

4100163
CLASS A BLOWER
RESISTOR

CLASS A DUCTS & VENTS

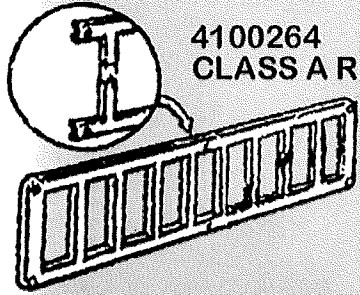

4100264
CLASS A RETURN AIR GRILL

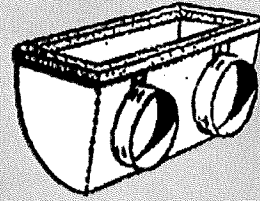

4100398
DEFROST PLENUM

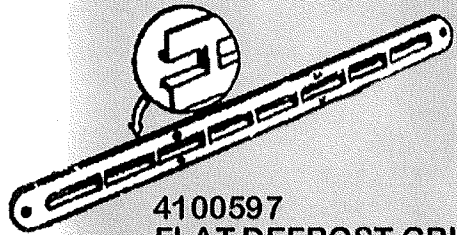

4100597
FLAT DEFROST GRILL

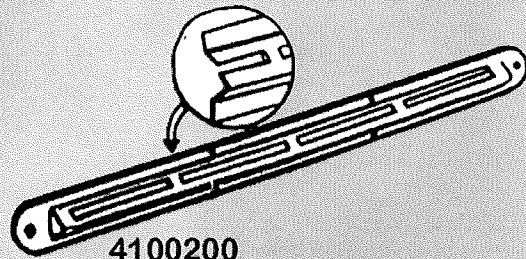

4100200
45 DEGREE DEFROST GRILL
4102600
45 DEGREE DEFROST GRILL
(27")

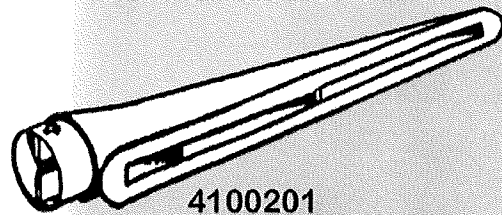

4100201
DEFROST OUTLET
4101309
DEFROST OUTLET (27")

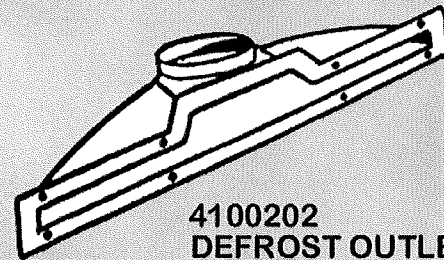

4100202
DEFROST OUTLET

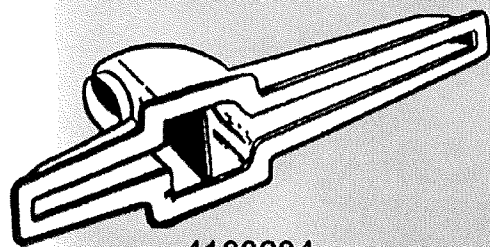

4100204
DEFROST OUTLET

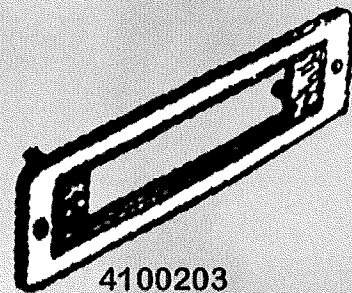

4100203
CONTROL HEAD BEZEL
7 3/4" x 2 1/2"

CONDENSER FANS & ACCESSORIES

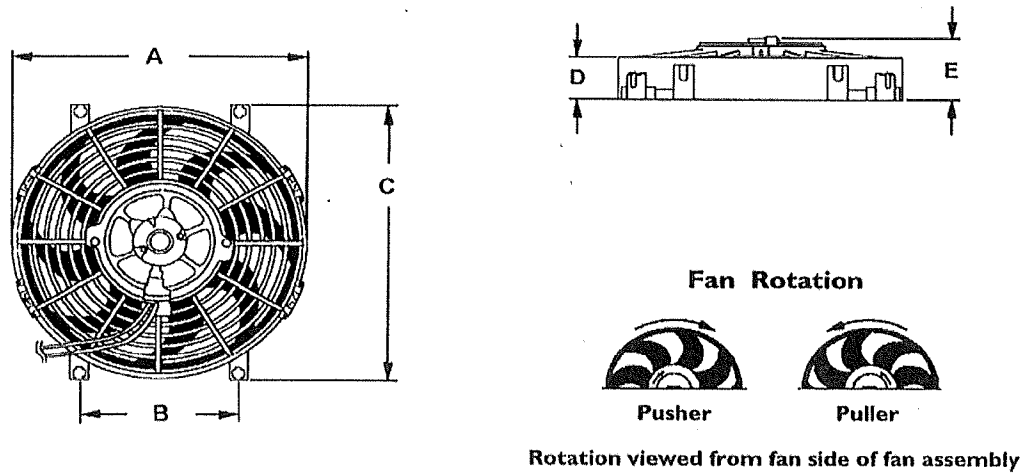

Thinline type excellent for auxiliary radiator or A/C condenser cooling.
Improves A/C performance and overall engine cooling.

ALL FANS 12 VOLT, GLASS FILLED NYLON EXC. AS NOTED

DESCRIPTION	CFM*	AMPS*	A	B	C	D	E	PART #
9" Push Thru	570	5.4-5.1	9.64"	4.97"	9.41"	1.41"	2.41"	430-378
9" Pull Thru	540	5.4-5.1	9.64"	4.97"	9.41"	1.41"	2.41"	430-380
11" Push Thru	880	8.8-8.4	12.52"	5.86"	11.50"	1.61"	2.44"	430-381
11" Pull Thru	875	8.8-8.5	12.52"	5.86"	11.50"	1.61"	2.44"	430-382
13" Push Thru	1350	10.5-10.7	14.45"	7.28"	13.19"	1.85"	2.87"	430-383
13" Pull Thru	1250	10.2-9.5	14.45"	7.28"	13.19"	1.85"	2.87"	430-384
16" Push Thru	1800	14.5-14.7	16.69"	8.11"	15.75"	1.93"	4.09"	430-385
16" Pull Thru	1810	14.6-14.3	16.69"	8.11"	15.75"	1.93"	4.09"	430-386
10" Reversible (Metal shroud & frame)								430-376
90° Mounting Bracket For All Above EXC. 430-376 (4 per kit)								430-300
Mercedes Fan (OE# 000-500-60-93)								430-400
Mercedes Fan (OE# 000-500-79-93)								430-401
Universal Mounting Kit For All Universal Electric Fans								250-103
Replacement Shroud For 430-376 Fan								250-376
Replacement Fan Blade For 430-376								430-390
Replacement Pancake Motor For 430-376 fan								100-376
Universal Adjustable Thermostatic Switch Package For Universal Electric Fan- Electro/Mech.								430-001
Universal Adjustable Thermostatic Switch Package For Universal Electric Fan - Electronic								430-002

* Measurements on Airflow (CFM) is based on unrestricted resistance. As restrictions increase CFM will decrease and Amps will increase. Numbers shown are Maximum for CFM and range for amperage.

250-280 - MOUNTING KIT (NO BRKTS)

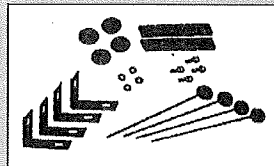
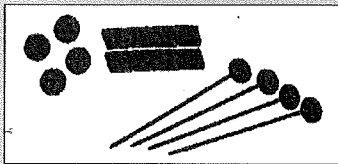

4100651 - MOUNTING TABS

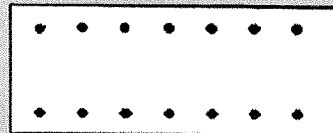
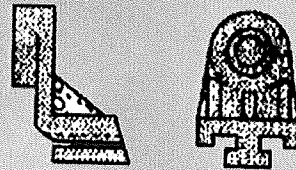

250-103 - MOUNTING KIT (WITH BRKTS)

4100742 - MOUNTING BRACKET

HEATER CORES / EVAPORATOR COILS

CORE5001

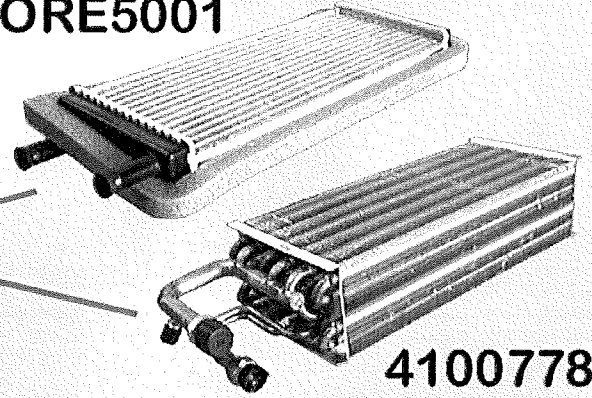
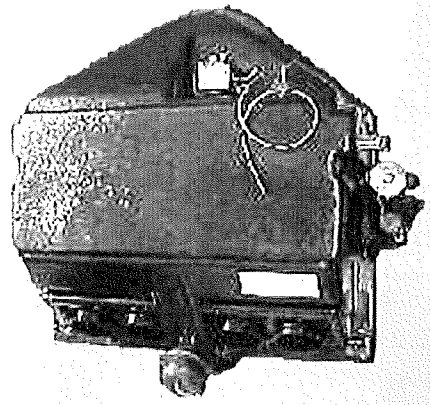

4100778

4570731

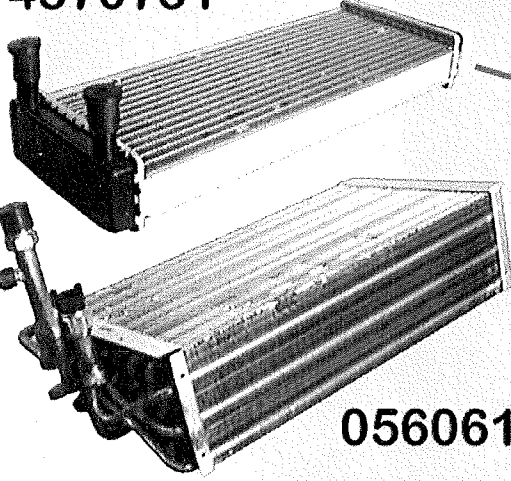

0560615

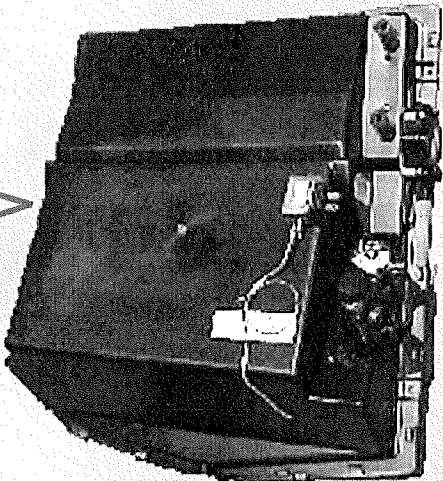

4100770

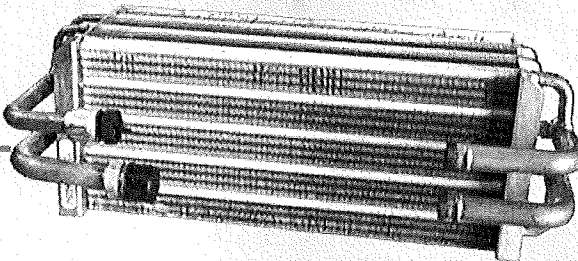
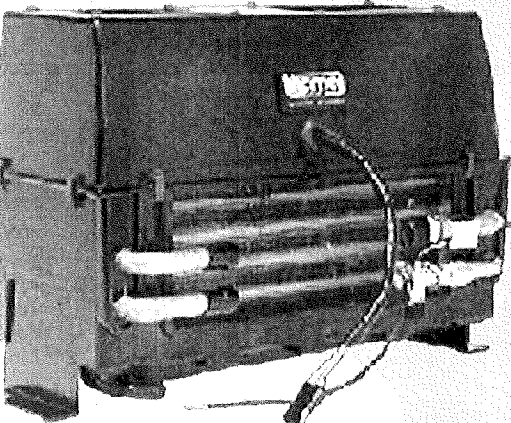

EXPANSION VALVES / BLOCKS

4103005

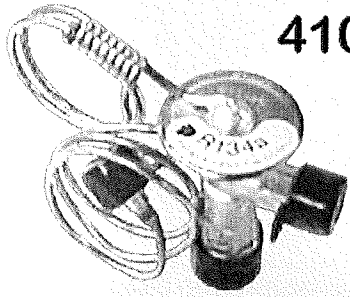

4103007

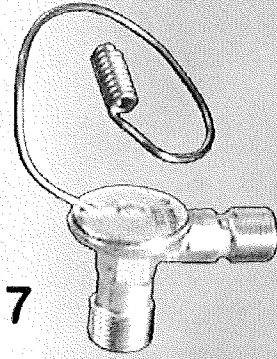

4103006

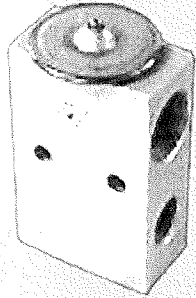

4100013

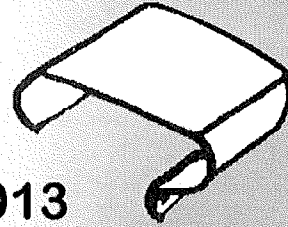

VACUUM PUMP / TANK

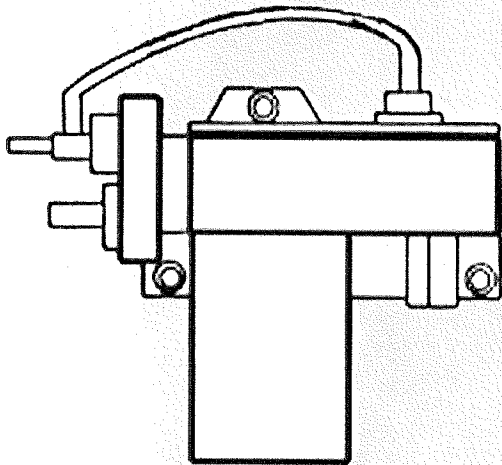

4570568
ELECTRIC VACUUM PUMP FOR
CLASS A MOTOR HOME WITH
DIESEL ENGINE.
12 VOLT AUTO SHUTOFF

3200029
VACUUM RESERVOIR TANK
W/ CHECK VALVE

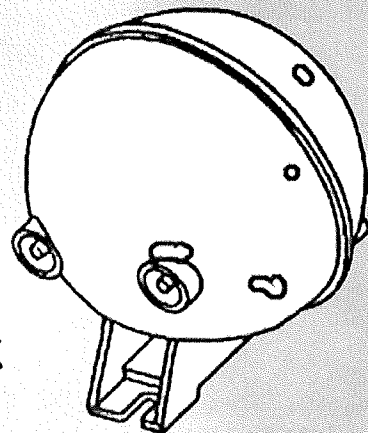

SWITCHES, RELAYS, ETC.

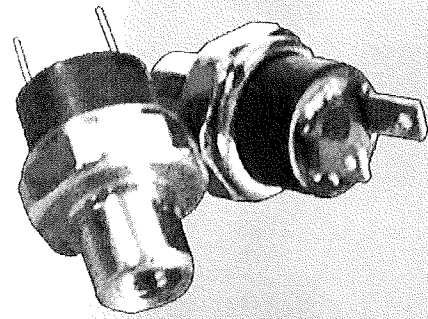

**4104011
HI / LO PRESSURE SWITCH**

**4103026
TRINARY SWITCH**

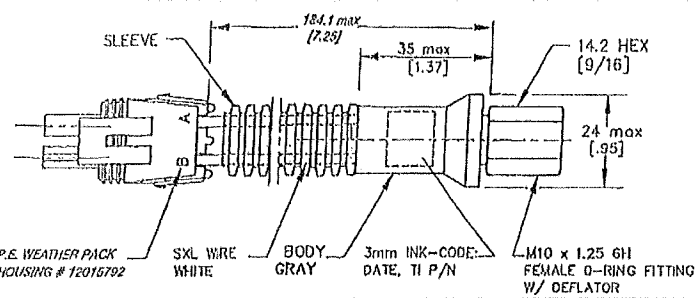
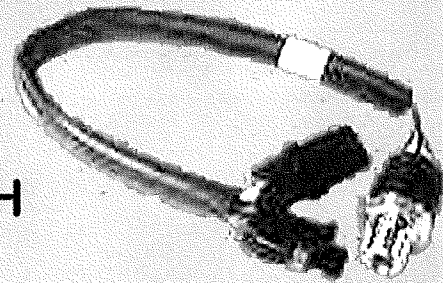

**4108434
FREIGHTLINER
HYDRAULIC FAN
SWITCH**

**4100066
FOUR POSITION SWITCH**

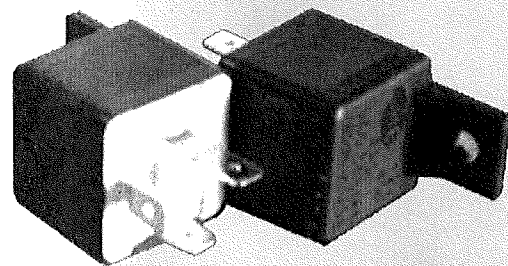
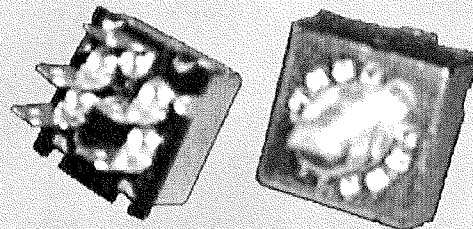

**4100345
RELAY FOR CONDENSER
FANS, AND HIGH SPEED
BLOWER FAN**

HEATER CONTROL VALVES & ACCESSORIES

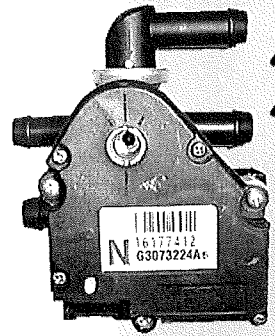

4100663
4104112

4100173

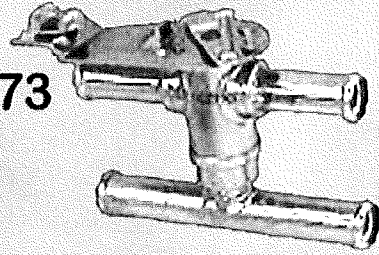

4100165



4108457

4103914

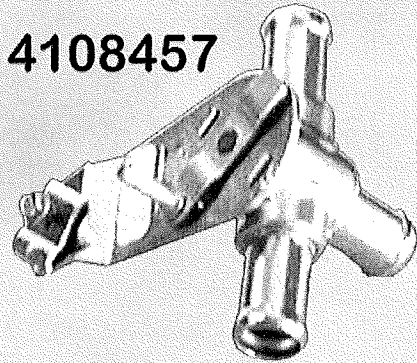
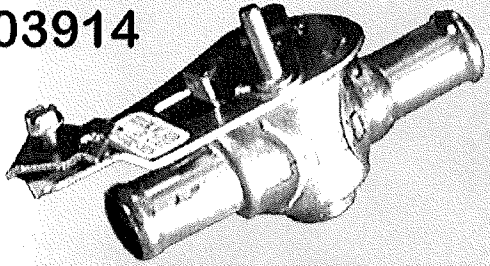

4100073



4100265

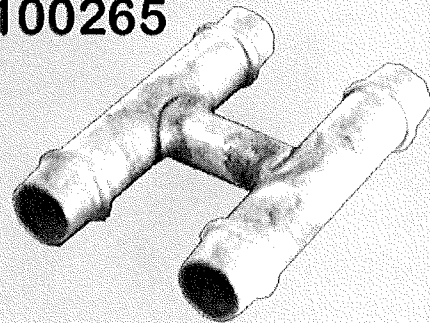

4100076

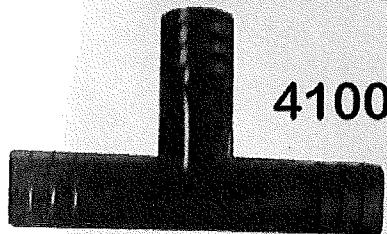

4100075



CONDENSER UNITS

0517401 OVERHEAD CONDENSER

This workhorse has been around for years, and is still one of our best sellers. A very high quality, rust resistant finish keeps this one looking good. Features two heavy duty, weather sealed motors, and a 12 FPI coil. Ideal for overhead or skirt mount applications, and is available in 24 volt. Bulkhead fittings and receiver drier included.

7.5" H x 28.5" W x 12.5" D

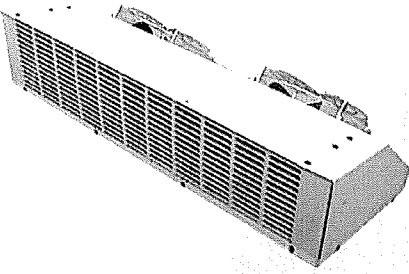

4513022 FRAME MOUNT CONDENSER

Shown with the 16" heavy duty, weather sealed fan and rail mounts, this condenser is a natural for mid-ship mounting.

22" H x 25" W

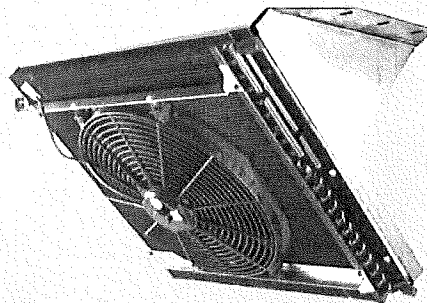

4513008 RV CONDENSER

With two 10" sealed electric fans, this is a perfect replacement for the Chevy "P" chassis

18" H x 38.25" W x 1.75" D
COIL: 18" x 28"

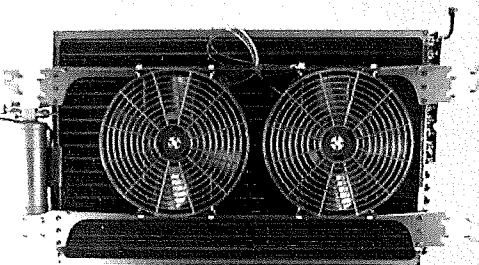

4513030 SKIRT/FRAME MOUNT CONDENSER

Very heavy duty steel enclosure, 16" weather sealed high capacity fan, multi-flow aluminum condenser, may be frame or rail mounted, weather resistant coating, available in 12 or 24 volt, trinary switch included.

OVERALL SIZE: 12.75" H x 30.25" W x 14.75" D
FIN SIZE: 25.75" W x 12.5 H x 1" D

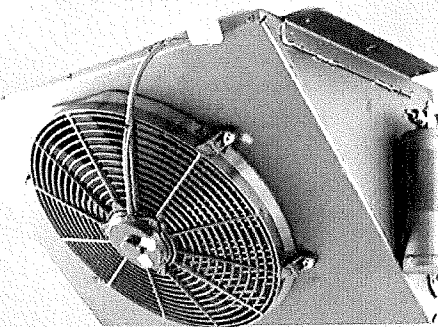

4513034 ENHANCED FLOW W/FAN R/H FITTINGS 4513035 ENHANCED FLOW W/FAN L/H FITTINGS

Multi-flow enhanced design, high capacity
14" weather resistant fan.

FIN SIZE: 25.75" W x 14 H

